

# NCP370GEVB

## NCP370 Over Voltage Protection Controller with Reverse Charge Control Evaluation Board User's Manual



ON Semiconductor®

<http://onsemi.com>

### EVAL BOARD USER'S MANUAL

#### Description

The NCP370 is an overvoltage, overcurrent and reverse control device. Two main modes are available by setting logic pins.

First mode is Direct Mode from Wall Adapter to the system. In this mode the system is both positive and negative overvoltage protected up to +28 V and down to -28 V. The wall adapter is disconnected from the system if the input voltage exceeds the overvoltage (OVLO) or undervoltage (UVLO) thresholds. At powerup, the  $V_{out}$  turns on 30 ms after the  $V_{in}$  exceeds the undervoltage threshold.

The second mode, called the Reverse Mode, allows an external accessory to be powered by the system battery or a boost converter. Here, the external accessory would be connected to the device input (bottom connector of system) and the device battery would be at the device output. In this case, overcurrent protection is activated to prevent accessory faults and battery discharge. Thanks to the NCP370 using an internal NMOS, the system cost and the PCB area of the application board are minimized. The NCP370 provides a negative going flag (FLAG(BAR)) output which alerts the system that a fault has occurred. In addition, the device has ESD protected input (15 kV Air) when bypassed with a 1.0  $\mu$ F or larger capacitor.

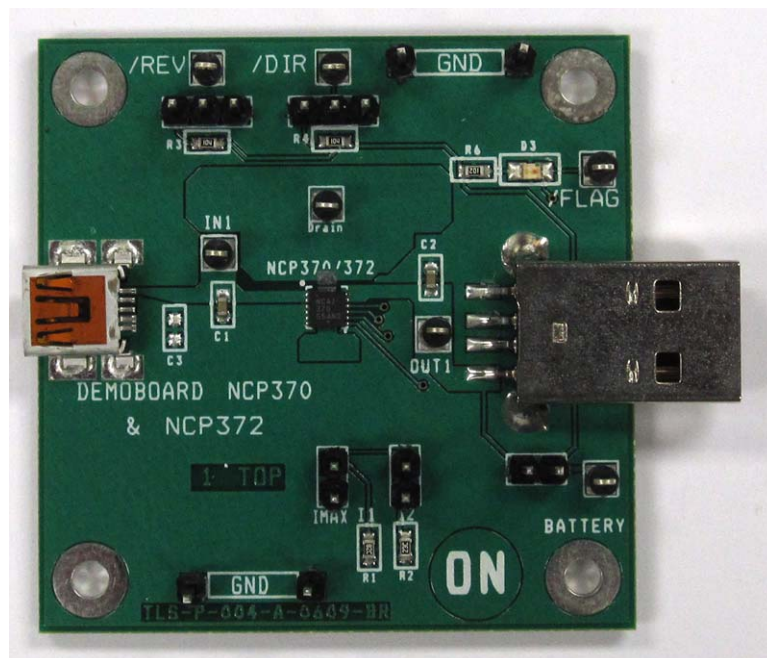

Figure 1. NCP370GEVB Board Picture

# NCP370GEVB

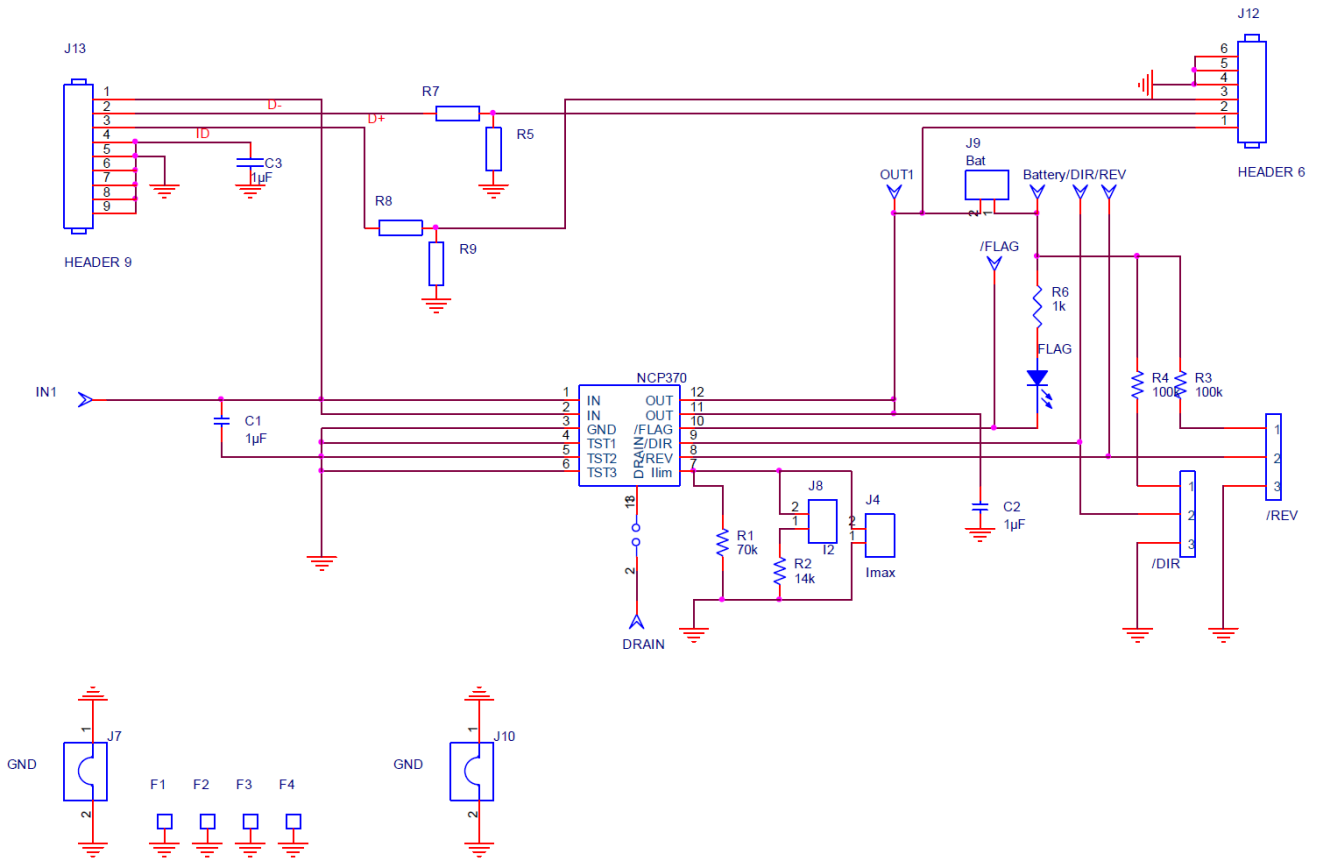

Figure 2. NCP370GEVB Board Schematic

# NCP370GEVB

**Table 1. BILL OF MATERIALS**

Quantity	Designation	Manufacturer	Digi key	Specifications
1	NCP370 LLGA3x3	ON Semiconductor		Over voltage protection
2	C1 (Cin), C2 (Cout)	Murata – GRM188R61E105KA12D	490-3897-1-ND	1 $\mu$ F 25V X5R CMS0805
1	C3 (ID): not mounted			
13	Test points:IN1, OUT1, BATTERY, FLAG, DRAIN, REV, DIR		5001K-ND	Hole diameter: 1.3mm
1	J13 (USB IN)	Molex	WM17116CT-ND	5 pins USB miniB
1	J12. (USB OUT)	Molex	WM17118-ND	4 pins USB A
1	FLAG	rohm	511-1287-ND	Green LED 0805
1	R6	susumu	Rr08p(value)dct-nd	1 k $\Omega$ . CMS0603 0.5%
2	R3, R4	susumu	Rr08p(value)dct-nd	100 k $\Omega$ . CMS0603 0.5%
Not mounted	R5,R7,R8,R9 (USB data)			
1	R1	susumu	Rr08p(value)bct-nd	69.8k $\Omega$ . CMS0603 0.5%
1	R2	susumu	Rr08p(value)bct-nd	16.9k $\Omega$ . CMS0603 0.5%
4	GND jumper: J7, J10		WM8083-ND	Jumper Ground 1mm pitch 10.16 mm
1x3	REV		WM8083-ND	SMB R 114 665 PCB Plated Gold
1x3	DIR		WM8083-ND	SMB R 114 665 PCB Plated Gold
1x2	lmax		WM8083-ND	SMB R 114 665 PCB Plated Gold
1x2	l2		WM8083-ND	SMB R 114 665 PCB Plated Gold
1x2	Battery		WM8083-ND	SMB R 114 665 PCB Plated Gold

# NCP370GEVB

## PCB

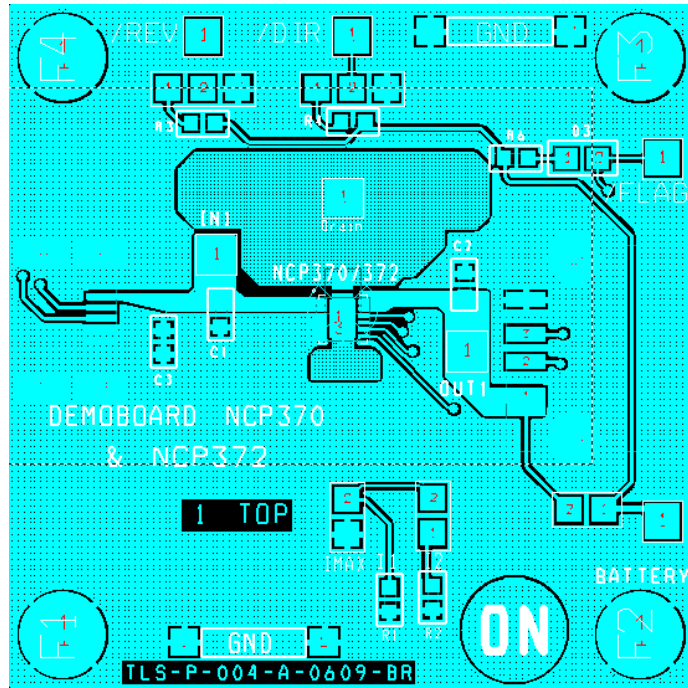

Figure 3. NCP370GEVB Board Layout (Top View)

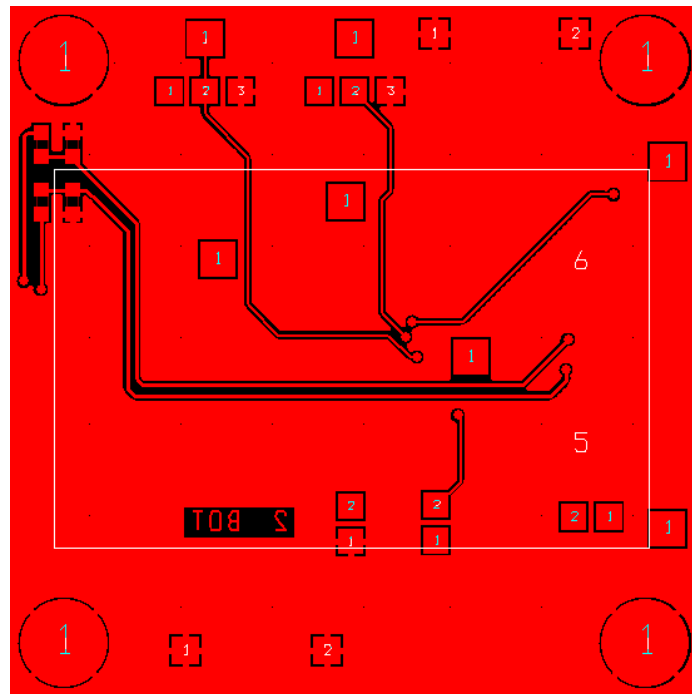
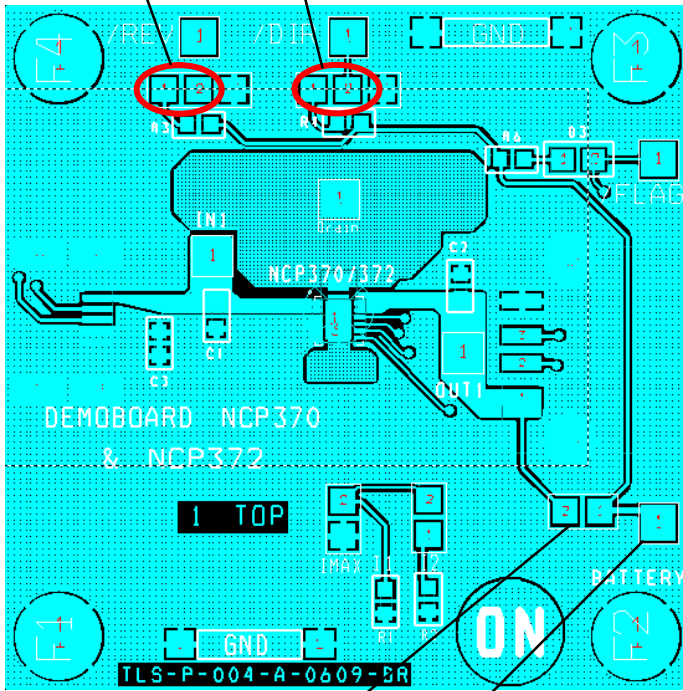

Figure 4. NCP370GEVB Board Layout (Bottom View)

# NCP370GEVB

## CONNECTING PROCESS

1. Place /REV strap and /DIR strap on left side ("1" logic) (connected to Vbat, through pull up resistor)



2. Let Battery strap opened.
3. Connect a Battery or power supply (4.2 V) on Battery test point (min 2 A capability).

# NCP370GEVB

4. Connect strap on lim.

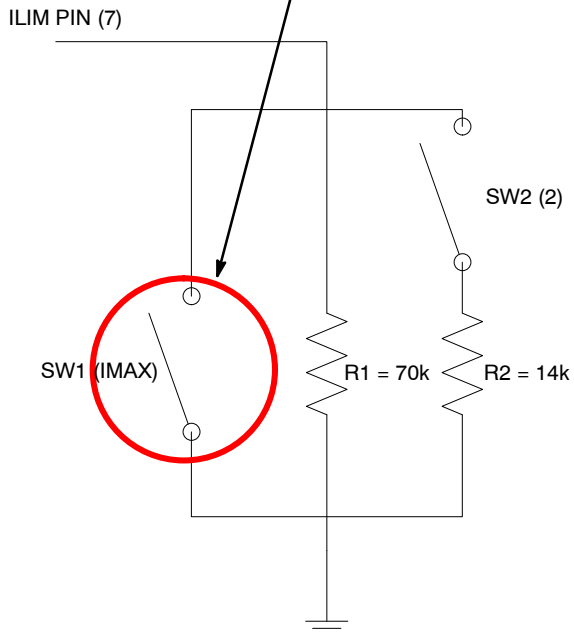
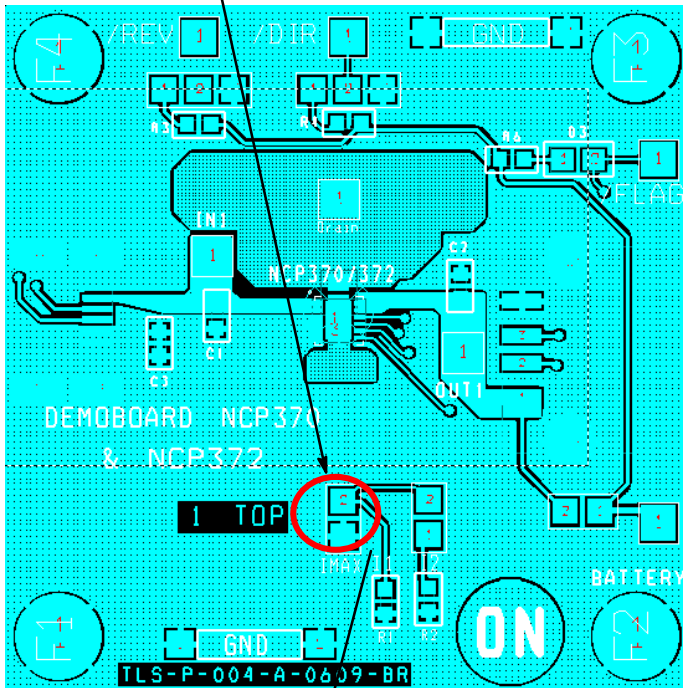

# NCP370GEVB

5. Select I limit threshold with pull down resistors connected on pin 7:

SW1	SW2	IOCP
0	0	500 mA
0	1	1 A
1	0	1.5 A
1	1	1.5 A

R1 = 70K

R2 = 14K

## Disable Mode:

6. Connect 10 V capability Vin Supply on IN1 test point.

a.) Set power supply to 5 V ⇒ Check Vout = 0 V and LED = off

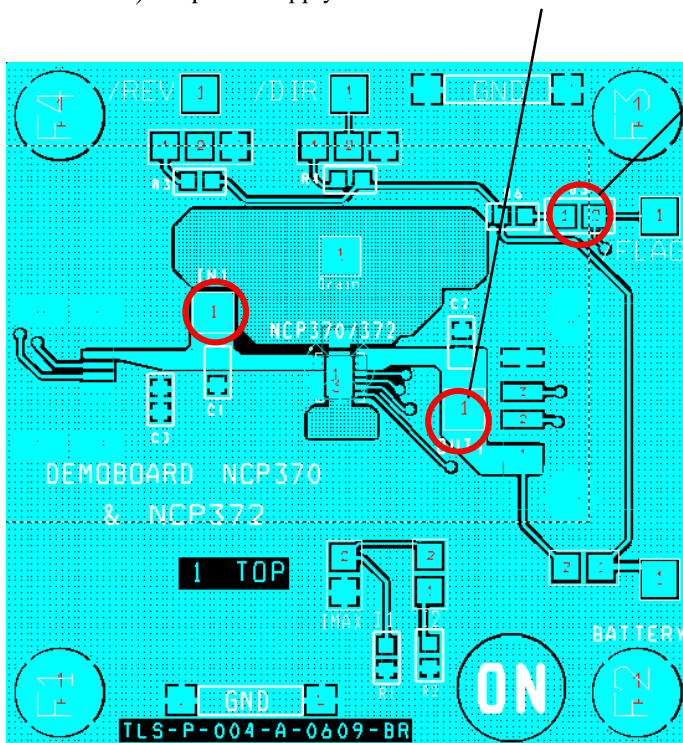

# NCP370GEVB

## Direct Mode:

7. Switch /DIR from left to right, 1 logic level to 0 logic level

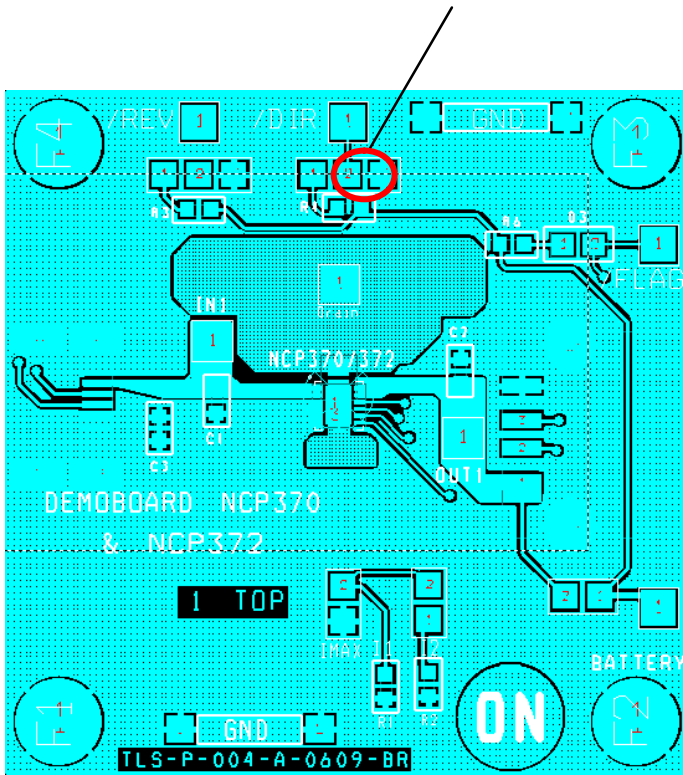

8. Check  $V_{out} = 5\text{ V}$  and Flag LED is still off

9. Set  $V_{in} = 7\text{ V}$

10. Check Flag LED = on, and  $V_{out}$  is 0 V.

11. Switch /REV from left to right, 1 logic level to 0 logic level

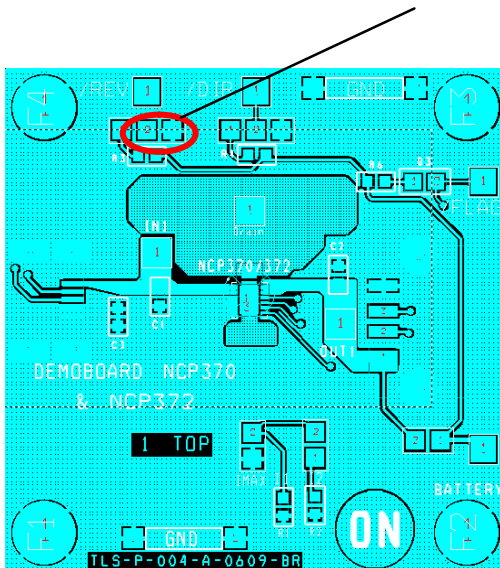

12. Check Flag LED = off, and  $V_{out} = V_{in} = 7\text{ V}$ .  
Disconnect  $V_{in}$  Supply.



# NCP370GEVB

## Reverse Mode:

13. Connect Set /DIR = 1, /REV = 1  
Disconnect Vin Power Supply from IN test points.  
Connect accessory on IN1 or IN2 test points.

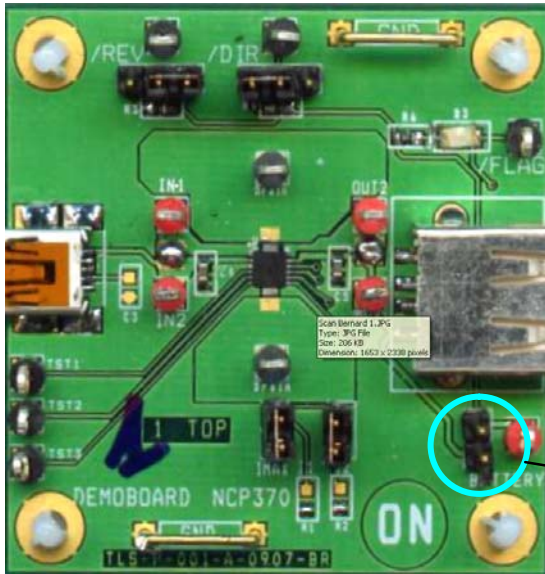

Put strap to connect Battery to Vout

14. Set /DIR = 1, /REV = 0:  $V_{out} = V_{in}$

If I accessory < I limit then  $V_{in} = V_{out} - R_{dson} \times I$

If I accessory > I limit then  $V_{in} = 0$  (Current regulation)

Power off.

15. Set /DIR = 1, /REV = 1
16. Disconnect accessory
17. Disconnect Battery

ON Semiconductor and  are registered trademarks of Semiconductor Components Industries, LLC (SCILLC). SCILLC reserves the right to make changes without further notice to any products herein. SCILLC makes no warranty, representation or guarantee regarding the suitability of its products for any particular purpose, nor does SCILLC assume any liability arising out of the application or use of any product or circuit, and specifically disclaims any and all liability, including without limitation special, consequential or incidental damages. "Typical" parameters which may be provided in SCILLC data sheets and/or specifications can and do vary in different applications and actual performance may vary over time. All operating parameters, including "Typicals" must be validated for each customer application by customer's technical experts. SCILLC does not convey any license under its patent rights nor the rights of others. SCILLC products are not designed, intended, or authorized for use as components in systems intended for surgical implant into the body, or other applications intended to support or sustain life, or for any other application in which the failure of the SCILLC product could create a situation where personal injury or death may occur. Should Buyer purchase or use SCILLC products for any such unintended or unauthorized application, Buyer shall indemnify and hold SCILLC and its officers, employees, subsidiaries, affiliates, and distributors harmless against all claims, costs, damages, and expenses, and reasonable attorney fees arising out of, directly or indirectly, any claim of personal injury or death associated with such unintended or unauthorized use, even if such claim alleges that SCILLC was negligent regarding the design or manufacture of the part. SCILLC is an Equal Opportunity/Affirmative Action Employer. This literature is subject to all applicable copyright laws and is not for resale in any manner.

## PUBLICATION ORDERING INFORMATION

**LITERATURE FULFILLMENT:**  
Literature Distribution Center for ON Semiconductor  
P.O. Box 5163, Denver, Colorado 80217 USA  
**Phone:** 303-675-2175 or 800-344-3860 Toll Free USA/Canada  
**Fax:** 303-675-2176 or 800-344-3867 Toll Free USA/Canada  
**Email:** orderlit@onsemi.com

**N. American Technical Support:** 800-282-9855 Toll Free  
USA/Canada  
**Europe, Middle East and Africa Technical Support:**  
Phone: 421 33 790 2910  
**Japan Customer Focus Center**  
Phone: 81-3-5773-3850

**ON Semiconductor Website:** [www.onsemi.com](http://www.onsemi.com)  
**Order Literature:** <http://www.onsemi.com/orderlit>  
For additional information, please contact your local  
Sales Representative